

Saramonic

Sound.Remarkable. 

UHF Wireless Microphone System
无线麦克风系统

UwMic9 

User Manual
用户手册



Statement

Please read this manual carefully before use and operate and store in strict accordance with the instructions provided. Please retain for future reference.

For any issues that cannot be resolved with the user manual, please refer to your retailer for help or contact us at: **info@saramonic.com**.

Cautions

1. Take care not to use the unit underwater or unprotected in rainy conditions. Store in a cool, dry place.
2. Designed for use and storage at normal temperatures. Do not move the unit from overheated to cold conditions frequently, and keep away from heat sources such as heaters and ovens.
3. When in use, or when storing, avoid contact with dust and moisture.
4. Do not subject to device to violent collisions, as this can damage the device.
5. In order to avoid acoustic feedback, do not hold the microphone close to loudspeakers.
6. For optimal sound detection, do not hold your hand against the microphone head.

General Introduction

The Saramonic UwMic9S wireless microphone system provides a premium 2-person wireless audio solution for Broadcast & TV, ENG, filmmakers, vloggers, mobile journalists and content creators. It is an easy-to-use, high-quality and flexible UHF system. The external input allows the receiver to be connected to a mic or line level device, such as a shotgun microphone, mixer, recorder or music player to capture additional sound or music. The system can be powered through its USB-C ports, allowing it to run for numerous hours on a USB-C 5V power bank.

UwMic9S RX Portable Receiver

Introduction

The Saramonic UwMic9S RX is a camera-mountable dual-channel UHF wireless receiver. It features wide switching RF bandwidth, a high-contrast OLED display and infrared synchronization between transmitter and receiver. The two detachable antennas can be rotated 360° for better reception. The receiver's output can be toggled between mono and stereo modes. The low-cut function on the receiver minimizes low-frequency rumble.

Product Structure

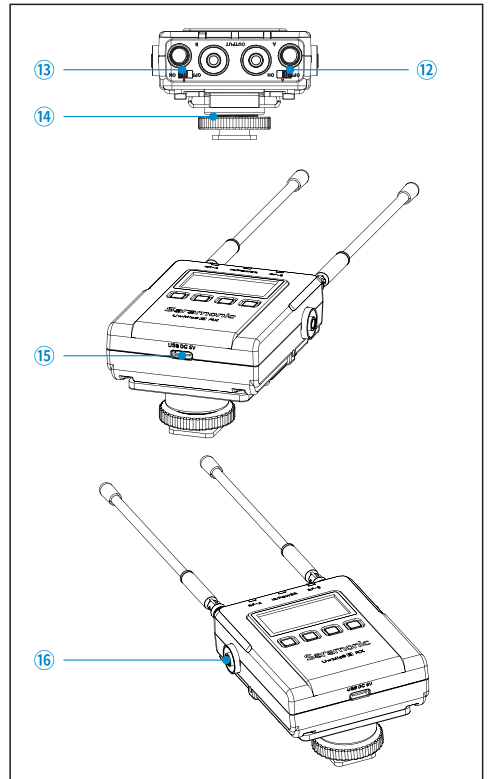
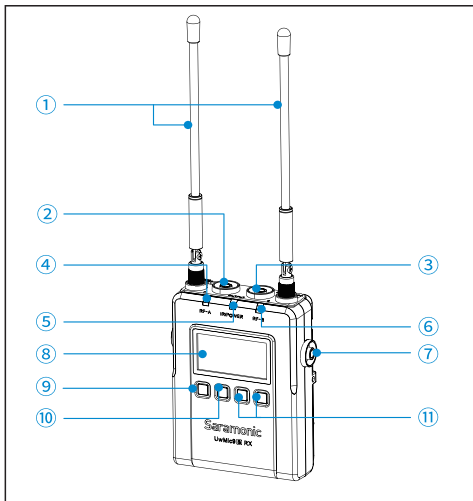

- ① **Detachable antennas**
- ② **Group A output jack**
Connect the RX to a video camera, camcorder, mixer or amplifier with the supplied output cables supplied.
- ③ **Group B output jack**
Connect the RX to a video camera, camcorder, mixer or amplifier with the supplied output cables.
- ④ **RF-A indicator**
The RF indicator displays the RF input level of group A as follows:
Solid Blue: Successfully matched.
Lights off: RF signal is disconnected.
- ⑤ **IR/POWER indicator**
Indicates the battery level as follows:
Solid blue: Sufficient battery level.
Solid Red: Battery low.
Charging Status:
Flashing Red: Charging.
Solid Blue: Fully charged.

⑥ **RF-B indicator**

The RF indicator displays the RF input level of group B as follows:
Solid Blue: Successfully matched.
Lights off: RF signal is disconnected.

⑦ **MIC IN/LINE IN jack**

Connect a 3.5mm microphone or a line level device to receiver.

⑧ **OLED display**

Display menus, please refer to "OLED Display Operation Guide" (page 4) for more details.

⑨ **Power button**

Long Press to turn the RX on or off.

⑩ **SET button**

Long press the SET button to change settings on the display menu.

Then, short press the SET button to confirm your setting change, or long press again to exit without saving.

⑪ **+ or - button**

Selects functions or values shown on the display.

⑫ **ON/OFF switch A (for Group A)**

⑬ **ON/OFF switch B (for Group B)**

⑭ **Cold shoe mount adapter**

⑮ **USB-C charging port (DC 5V)**

⑯ **3.5mm headphone output**

Connect headphones to monitor the audio.

Attaching Accessories

Connect the supplied cable to the output jack.

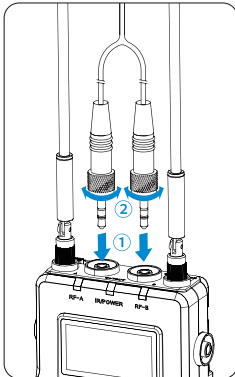

① Choose the corresponding cable and plug into the OUTPUT jack.

② For a secure connection, turn to lock the connector.

It is possible to attach a belt clip. Please Refer to "Attaching Accessories" (page 7).

Attaching the shoe mount adapter.

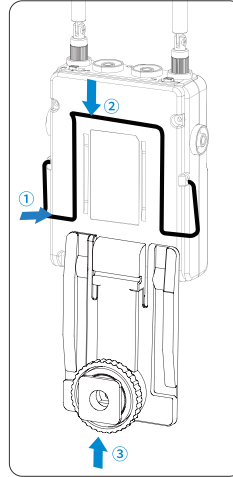

① Please attach the belt clip upside-down before attaching the shoe mount adapter.

② Press the bottom of the belt clip to make some space between the belt clip and the receiver.

③ Align the belt clip with the two vertical grooves on the shoe mount adapter and insert the adapter in the direction of the arrow.

④ Push the shoe mount adapter in fully until the belt clip fits into the horizontal groove on the adapter's holder.

OLED Display Operation Guide

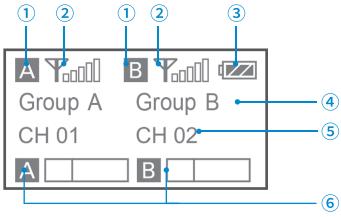

Home screen: If no operation is performed for 20 seconds on the other screens, the display will automatically return to the home screen.

① **Group icon**

- [A] Indicates the power of group A is turned off.
- [A] Indicates the power of group A is turned on.

② **RF level indicator**

Indicates the current reception level.

③ **Battery level indicator**

Displays the battery level. Please charge the devices immediately as soon as the indicator starts flashing.

④ **Name of the channel group**

⑤ **Current channel**

Displays the current channel number.

⑥ **Audio input level meter**

Displays the audio input level.

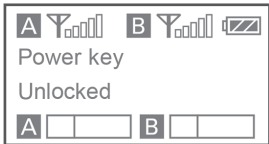

Power key: Long press the SET button to unlock or lock the power key. Lock the power key to prevent the receiver being turned off accidentally while in use.

- **Unlocked:** Long press the power key to turn the receiver on or off (System default).
- **Locked:** The receiver will not be turned off even after the power key is pressed.

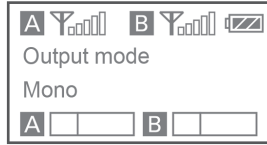

Output mode: The output mode can be set to mono or stereo. When the output mode is in mono, the audio from the left and right channel will be mixed. When in stereo, receiver A's and receiver B's audio output will be separated to the left and right of the stereo output. If using two transmitters, please make sure the ON/OFF switch of the group A and B are set to ON. System default is mono.

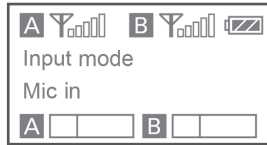

Input mode: The input mode can be set to Mic in or Line in.
 Mic in: for connecting a 3.5mm TRS microphone to the receiver.
 Line in: for connecting a line-level device to the receiver.
 System default: Mic in.

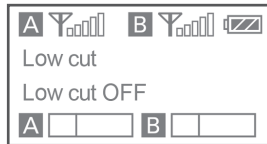

Low cut: Long press the SET button to turn the low-cut function on or off. To attenuate signals with frequencies lower than 150 Hz, the default is "Low Cut OFF."

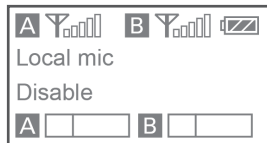

Local mic: Disable or enable the external input by long pressing the SET button.
 Enable: Allows the receiver to connect to an external audio device.
 Disable: The Mic/Line input jack of the receiver cannot be used when set to "Disable." Default is "Disable."

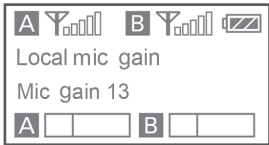

MIC GAIN: Adjust the external microphone's gain level (0-15). Default is "13".

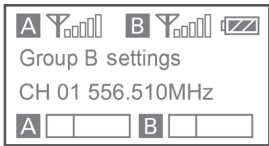
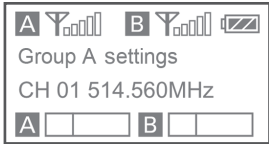

Select channel: For details of operation, please refer to "Manually setting the receiver channel" (page 10).

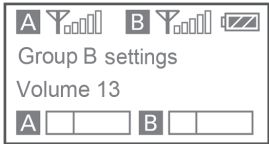
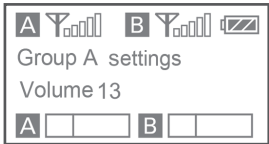

Set output volume: Set the volume of output audio within the range of 0 to 15. The setting is retained even after the power is turned off. Default volume is 13.

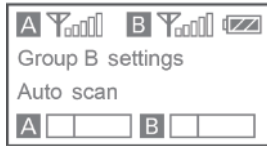
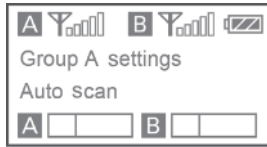

Auto scan function: Automatically scan an available and clear channel. For details of operation, please refer to "Using the auto scan function" (page 9).

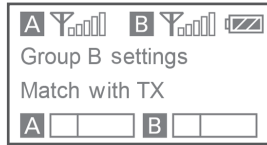
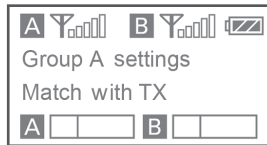

Infrared matching function: Match the receiver and transmitter via infrared. For details of operation, please refer to "Matching the receiver and transmitter channel" (page 10).

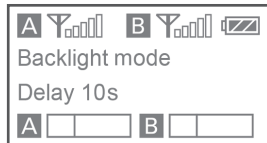

Set backlight: Set the background LED light to ON or Delay by 60, 30, or 10 seconds. Default setting is "Delay 30s."

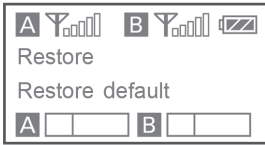

Restoring default setting

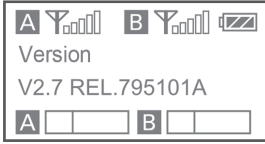

UwMic9S RX Version



Language Setting: English/ 中文 (Chinese) Default is English

Body-pack Transmitter UwMic9S TX

Introduction

The Saramonic UwMic9S TX is a body-pack transmitter. It features an easy-to-read OLED display, a detachable antenna and built-in rechargeable battery. With the line input and mic input jacks, it can accept audio from the included 3.5mm locking lavalier mic or other line-level devices. A short press of the power button mutes the mic between takes. The locking function prevents the transmitter from being turned off accidentally.

Product Structure

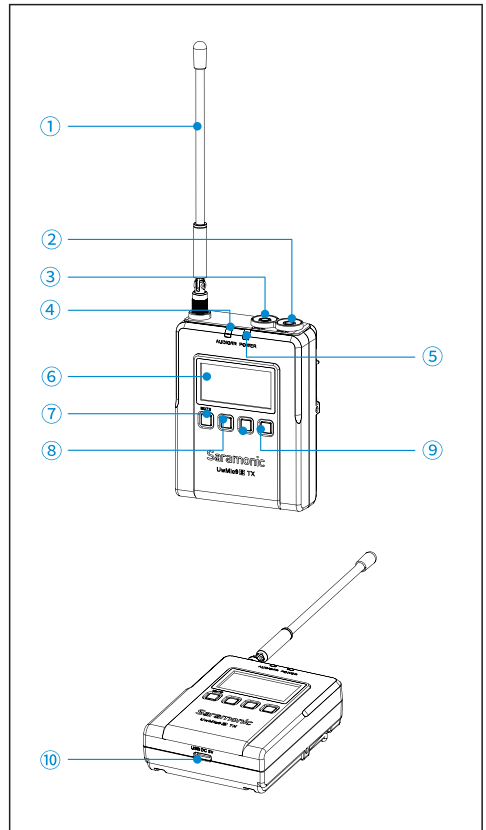

- ① **Detachable antenna**
- ② **MIC IN jack**
Connects to the supplied 3.5mm lavalier microphone.
- ③ **LINE IN jack**
Connects to the line level devices.
- ④ **AUDIO indicator / IR (infrared detector)**
AUDIO indicator: Indicates the audio input level. IR (infrared detector): Receives the frequency from the receiver.
Solid Blue: Audio input level is appropriate.
Flashing Red: Audio is muted. For details on setting the mute function, please refer to "Set Mute key" (page 8).
- ⑤ **POWER indicator**
Indicates the battery level as follows: Solid Blue: Sufficient battery level.
Solid Red: Low battery.
Charging Status:
Flashing Red: Charging.
Solid Blue: Fully charged.
- ⑥ **OLED display**
For display menus, please refer to the "OLED Display Operation Guide" (page 8) for more details.
- ⑦ **Power / Mute button**
Power ON:
Press button for one second or longer
Power OFF:
Press button until it turns off
Mute ON/OFF:
Short press button
- ⑧ **SET button**
Long press the SET button to enter the displayed menu. Then, short press the SET button to confirm your option or long press again to exit without saving.
- ⑨ **+ or - button**
Selects functions or values shown on the display.
- ⑩ **USB-C charging port (DC 5V)**

Attaching Accessories

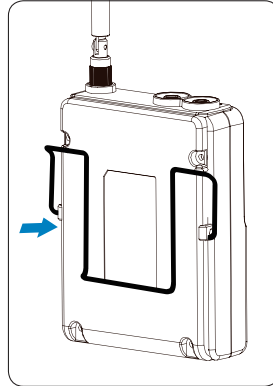

1. Attaching a belt clip

Insert one end of the belt clip into one of two holes on either side of the transmitter, and then insert the other end into the hole on the other side.

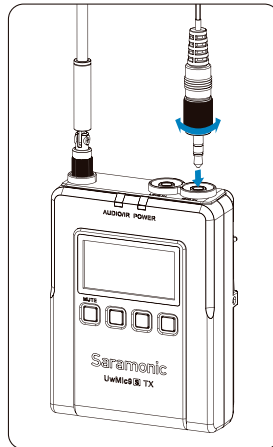

2. Connecting the microphone

For a secure connection, turn to lock the connector.

Note: Please turn off the transmitter before attaching or removing the microphone.

OLED Display Operation Guide

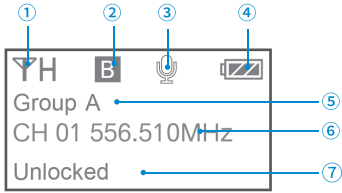

Home screen. If no operation is performed for 20 seconds on the other screens, the display will automatically return to the home screen.

- ① **RF transmission power indicator:** indicates the current transmission power level.
For details on setting the level, please see "Select RF power level" (page 8).
- ② **Channel group indicator:** indicates the current group.
- ③ **Mute indicator:**
Mute OFF Mute ON
- ④ **Battery level indicator:**
Displays the battery level. Please recharge the device immediately as soon as the indicator starts flashing.
- ⑤ **Name of the channel group**
- ⑥ **Channel and frequency:**
Indicates the current channel and frequency.
- ⑦ **The status of Power / Mute button.**

Menu display section. Displays various functions. Press the + or - button to switch functions.

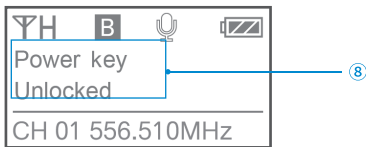

Set Power key: Select Unlocked or Locked. Set "Locked" to lock the power button to prevent the unit from being turned off accidentally while in use. Default is "Unlocked."

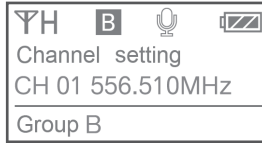

Select Channel: Long press the SET button to enter the menu. Use the "+" and "-" to select the channel you need and short press the SET button to confirm.

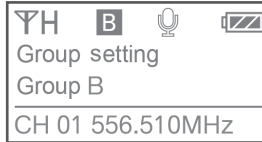

Select Group: You can choose "A" or "B" channel group. Each group has 96 channels. The default is "Group A."

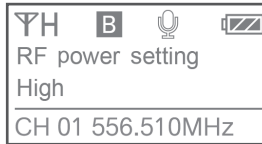

Select RF power level: You can set the transmitted RF power to High, Medium or Low. The default is "High."

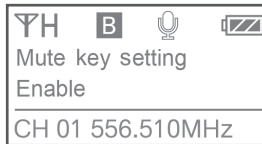

Set Mute key: If you want to mute the audio, please select "Enable" first and then short press the power button. If "Disable" selected, mute function will be disabled. Short press the power button won't mute the product. The default is "Enable."

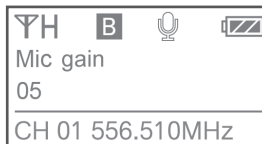

Microphone Gain Setting: If you want adjust the microphone's gain, you can set the microphone's gain from 00-08. The default is "05".

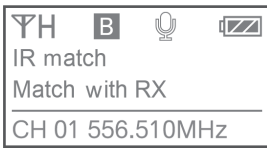

IR Match: Set to match with the receiver. The screen will display "Matching" when in process. After successful matching, it will read Match success. If failed to be matched within 20s, the screen displays "Match time out"

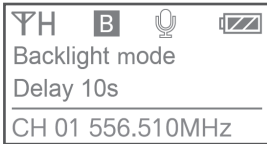

Set Backlight: Select ON or Delay by 10, 30, or 60 seconds. The default is "Delay 30s."

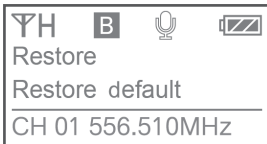

Restore default setting

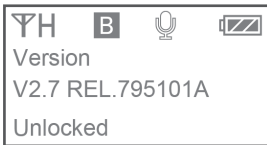

UwMic9S TX Version

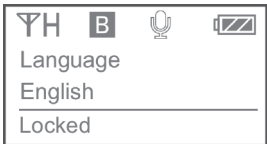

Language Setting: English/ 中文 (Chinese)
Default is English

Operation Guide

1. Connect the receiver to the microphone input of a camera, camcorder or mixer with the supplied cable.

2. Turn on the receiver by long pressing the power button.

3. Set the channel of the receiver in two ways:

① By using the auto scan function

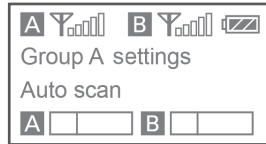

Using the + or - button to display the auto scan screen on the receiver.

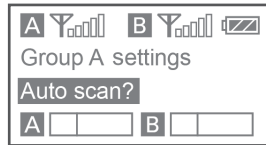

Long press the SET button to select "Auto scan?"



The channel with the least noise and interference will be displayed.

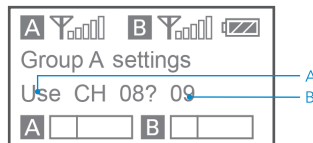

Press the SET button to confirm.

A. Indicates that the current channel with the least noise is CH 08 and asks you if you would like to use it. You can short press the SET button to confirm the channel within 20 seconds or long press the SET button to exit the displayed menu without saving.

B. 20 seconds Countdown

Note:

- ① After 20 seconds have elapsed, the display returns to the home screen without saving.
- ② Some noise may occur when power is turned on, so it is possible to turn down the audio input level of devices connected to the receiver accordingly.

- ② Manually setting the receiver channel:
Use the + or - button to display the channel menu on the receiver.

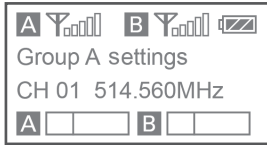

Long press the SET button to select the menu.

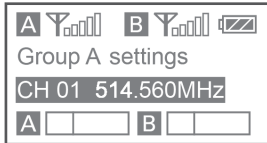

Use the + or - button to select the desired channel and confirm it by short pressing the SET button.

4. Matching the receiver and transmitter channel:

- ① Matching by infrared transmission: transmission is used to transfer the frequency set on the receiver to a transmitter.

- Turn on the transmitter and receiver.
- Use the + or - button to display the "Match with TX" menu on receiver.

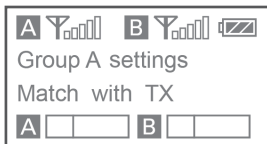

- Use the + or - button to display the "Match with RX" menu on transmitter.

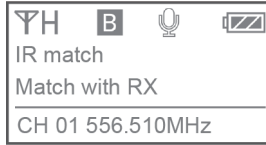

- Long press the SET button to select the menu and then short press it to confirm.
- Place the infrared transmitter port (the IR indicator) of the receiver near the infrared detector (the IR indicator) of the transmitter.
- If "Sync Finished" is displayed on the OLED screen, the frequency for use on the transmitter is set.
- After matching successfully, the RF indicator of the receiver will be in solid blue. The display will automatically return to the home screen.

- ② Manually setting the transmitter channel
Use the + or - button to display the channel menu on the transmitter.

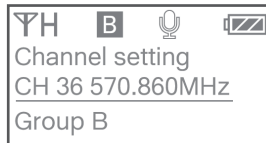

Long press the SET button to select the menu.

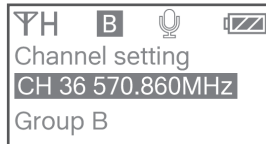

Use the + or - button to select the same channel as the receiver, and confirm it by short pressing the SET button.
After matching successfully, the RF indicator of the receiver will be in solid blue.

Specification

Receiver UwMic9S RX

Channel number	96
Channel group	A and B
Oscillator type	PLL synthesizer
Operating range	Up to 328'(100m)
Audio output connector	3.5 mm jacks (A and B channel output), 3.5mm headphone output
Audio input connector	3.5mm jack (MIC IN /LINE IN jack)
Antenna	1/4λ wire antenna
Audio output level	-60 dBV
Headphone output level	30mW (16 Ω)
Carrier frequencies	514 MHz - 596 MHz
Sensitivity	-95 dBm
Signal-to-noise ratio	75 dB or more
Reference deviation	±5 kHz (-60 dBV, 1 kHz input)
Frequency response	40 Hz to 18 kHz (+/-3dB)
Distortion	0.2% or less
Reference audio input level	-60 dBV (MIC input, 0 dB attenuation)
Built-in battery capacity	2000mAh
Power Requirements	Built-In Li-ion Battery or USB-C DC 5V
Continuous use time	8 hrs
Dimensions	87*64*25mm
Weight	175g (6.17 oz)
Operating temperature	-10 °C to 50 °C
Storage temperature	-20 °C to +55°C

Transmitter UwMic9S TX

Channel number	96
Channel group	A and B
Oscillator type	PLL synthesizer
Operating range	Up to 328'(100m)
Audio input connector	3.5mm LINE IN jack, 3.5mm MIC IN jack
Antenna	1/4λ wire antenna
Carrier frequencies	514 MHz - 596 MHz
RF output power	≤10mW
Signal-to-noise ratio	75 dB or more
Reference deviation	±5 kHz (-60 dBV, 1 kHz input)
Frequency response	40 Hz to 18 kHz (+/-3dB)
Distortion	0.2% or less
Reference audio input level	-60 dBV (MIC input, 0 dB attenuation)
Built-in battery capacity	2000mAh

Power Requirements	Built-In Li-ion Battery or USB-C DC 5V
Continuous use time	8 hrs
Dimensions	87*64*25mm
Weight	157g (5.54 oz)
Operating temperature	-10 °C to 50 °C
Storage temperature	-20 °C to +55°C

List of contents

UwMic9S Kit1(TX+RX)

1×Body-pack transmitter: UwMic9S TX
1×Portable receiver: UwMic9S RX
1×DK3A Omnidirectional Lavalier Microphone
1×1'(30cm) SR-C2004 3.5mm TRS Male to Dual Locking 3.5mm TRS Male Y-Cable
1×1.3' (40cm) XLR to Locking 3.5mm TRS Audio Cable
2×3.9'(1.2m) USB-C Charging Cables
1×2.6' (80cm) Locking 3.5mm TRS Audio Cable for Cameras
3×Antennas
2×Belt Clips
1×Cold Shoe Mount Adapter

UwMic9S Kit2 (TX+TX+RX)

2×Body-pack transmitters: UwMic9S TX
1×Portable receiver: UwMic9S RX
2×DK3A Omnidirectional Lavalier Microphones
1×1'(30cm) SR-C2004 3.5mm TRS Male to Dual Locking 3.5mm TRS Male Y-Cable
2×1.3' (40cm)XLR to Locking 3.5mm TRS Audio Cable
1×2.6' (80cm) Locking 3.5mm TRS Audio Cable for Cameras
3×3.9'(1.2m)USB-C Charging Cables
4×Antennas
3×Belt Clips
1×Cold Shoe Mount Adapter

声明

请在使用前仔细阅读本手册，并严格按照说明进行操作和存储。请保存以供将来参考。如果用户手册不能帮助您解决某些问题，请向零售商寻求帮助或给我们发送电子邮件：info@saramonic.com。

注意事项

1. 请勿在水下使用本机，也不要使其受到雨淋。请存放在阴凉干燥处。
2. 请在常温下使用和存放。请勿经常在冷热交替状态下使用设备，并远离加热器和烤箱等热源。
3. 使用和存放时，请注意防尘和防潮。
4. 请勿剧烈碰撞。
5. 为避免声音异常，请勿将麦克风靠近扬声器。
6. 为获得最佳拾音效果，请勿将手放在麦克风咪头上。

概述

枫笛 UwMic9S 是一款 UHF 无线麦克风系统，为视频播客，新闻制作人，视频创作者等人群提供专业的音频解决方案。易于使用的高清显示屏和小尺寸接收器可完美连接在相机、摄像机上。UwMic9S RX 接收器内置麦克风 / 线性输入孔，支持背景音乐或其他录音设备声音输入。此外，UwMic9S 还支持外接直流电 5V 移动电源充电，实现录音过程不间断。

便携式接收器 UwMic9S RX

介绍

枫笛 UwMic9S RX 是一款便携式接收器，它可提供宽频率范围并覆盖多个通道，易于使用的 OLED 高清显示屏和小尺寸接收器可完美连接在相机、摄像机上。UwMic9S RX 具有自动扫描功能，可以自动搜索可用传输频率通道设置，同时也可选择输出信号为单声道 / 立体声模式。

产品结构

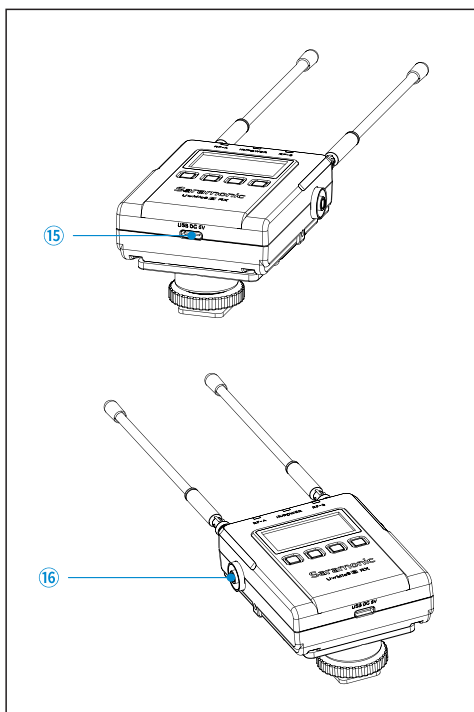
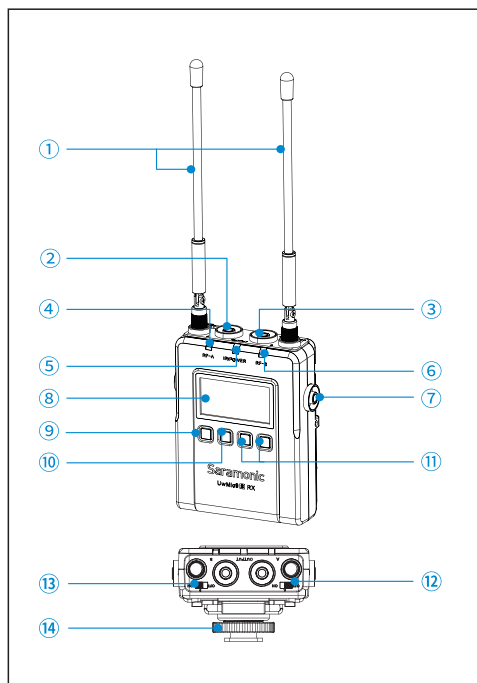

- ① 天线
- ② A 通道输出孔
请选择适配的输出线，将 RX 连接到单反相机，摄像机，混音器，录音笔等设备。
- ③ B 通道输出孔
请选择适配的输出线，将 RX 连接到单反相机，摄像机，混音器，录音笔等设备。
- ④ RF-A 射频指示灯
RF 射频显示状态：
亮蓝灯：联机成功状态
灯灭：未联机状态
- ⑤ 红外射频端口 / 电源指示灯
电源指示灯显示状态：
亮蓝灯：电量充足
亮红灯：低电量
充电时指示显示状态：
闪红灯：处于充电状态
亮蓝灯：电量充满
- ⑥ RF-B 射频指示灯
RF 射频显示状态：
亮蓝灯：联机成功状态
灯灭：未联机状态

- ⑦ 麦克风 / 线性输入孔
3.5mm 领夹麦克风 / 线性输入设备接入孔
- ⑧ OLED 屏幕
详情请参考“OLED 显示屏操作指南”（第 16 页）
- ⑨ 电源键
长按电源键开启 / 关闭 RX
- ⑩ SET 键
长按 SET 键进入菜单，短按为确认当前设置操作，再次长按取消当前设置操作。
- ⑪ +/- 按键（调整各参数数值大小）
- ⑫ A 通道开关键
- ⑬ B 通道开关键
- ⑭ 冷靴座
- ⑮ Type-C 充电口（直流电 5V）
- ⑯ 耳机监听孔

配件安装

音频转接线接入操作

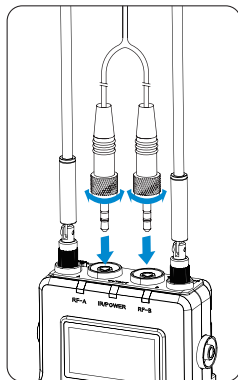

- ① 请选择适配的音频转接线连接输出孔。
- ② 拧紧锁头，确保音频转接线连接稳固。

背夹安装操作请参照第 19 页“配件安装”

冷靴座卡板安装操作

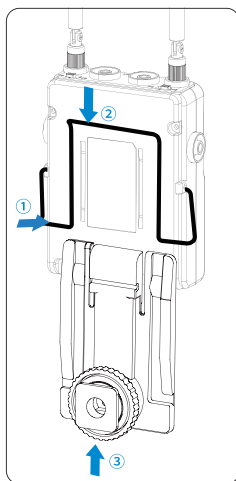

- ① 在安装卡板之前，请如图先安装金属背夹。
- ② 按压背夹为卡板预留出空间。
- ③ 卡板凹槽必须对准与背夹的竖直方向位置。
- ④ 推入卡板，直至凹槽卡点到位，完成安装。

OLED 显示屏操作指南

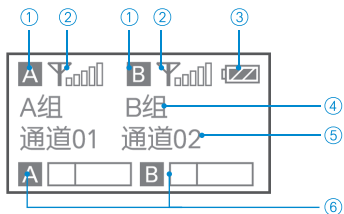

主菜单界面

如果超过 20 秒不操作，显示屏会自动跳转回主菜单界面。

① 通道开关图示

A 表示 A 通道处于关闭状态

A 表示 A 通道处于打开状态

② RF 信号强度指示

用来指示当前信号强度

③ 电池电量格

显示电池电量水平。若图标为空格且开始闪烁，请及时对产品进行充电。

④ 频道名称

⑤ 当前频段

⑥ 频道音频输入情况

显示通道音频实时输入情况



电源键设置：长按 SET 键设置锁定 / 解锁电源键。锁定电源键可开启防误触功能。

• 解锁状态：长按电源键开机或关机操作（系统默认设置）

• 锁定状态：设定锁定选项后，防误触功能开启；长按电源键，设备不会关机，预防误操作而导致录音中断情况发生。



输出模式选择：

立体声 / 单声道模式。

立体声模式：左声道（A 通道）和右声道（B 通道）

独立输出

单声道模式：左声道（A 通道）和右声道（B 通道）

混合输出（系统默认设置）



输入模式选择：

麦克风 / 线性输入模式。

麦克风输入模式：接入 3.5mm 领夹麦克风。（系统默认设置）

线性输入模式：接入线性输入设备。



低切设置

长按 SET 键设置开启 / 关闭低切功能

开启低切功能：对低于 150Hz 的频率进行衰减

关闭低切功能：（系统默认设置）



输入控制设置

当需要使用 RX 的 MIC IN/LINE IN 接口时，需要将输入设置为开启。

长按 SET 键设置接收器输入控制

启用输入控制：

MIC IN/LINE IN 输入孔可识别 3.5mm 领夹麦克风 / 线性输入设备

关闭输入控制：

MIC IN/LINE IN 输入孔不识别 3.5mm 领夹麦克风 / 线性输入设备（系统默认设置）



麦克风增益

外接麦克风增益值调节范围(0-15)，默认值是“13”



频道调试

具体操作请参照“手动设置接收器频道”（21页）



输出音量设置

输出音量设置调节范围（0-15），默认值是“13”



自动搜索频道功能

自动搜索无干扰频道，详情参照“使用自动搜索频道功能”（21页）



红外配对功能

详情请参照“接收器和发射器配对”（21页）



背光灯设置

LED背光灯设置：常亮/延时60/30/10秒设定，（延时30s为系统默认设定）

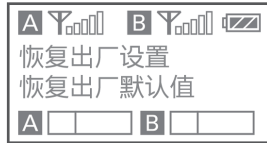

确认恢复出厂设置后，RX的相关参数将被恢复到默认出厂值。



UwMic9S RX 当前版本号



语言版本设置：英语 / 中文 默认设置是英语

腰包发射器 UwMic9S TX

简介

枫笛 UwMic9S TX 是一款腰包式发射器。TX 腰包式发射器是完整 UwMic9S 音频系统的一部分，它可提供数字音频处理级音质。

UwMic9S TX 发射器支持外接麦克风 / 线性设备的声音输入，并支持静音调制功能。此外，发射器具有防误触功能，可以防止录音过程中误操作按键而导致录音中断的情况发生。

产品结构

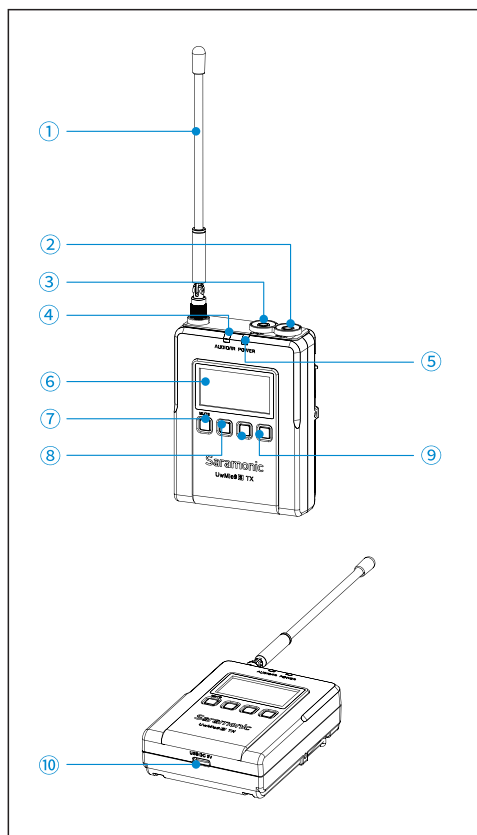

- ① 天线
- ② 麦克风输入
接入 3.5mm 领夹麦克风
- ③ 线性输入
接入线性输入设备
- ④ 音频指示灯 / 红外射频端口
RF 射频显示状态：
亮蓝灯：射频信号强
闪红灯：射频信号断开（静音状态）
- ⑤ 电源指示灯
电源指示灯显示状态：
亮蓝灯：电量充足
亮红灯：低电量
充电时指示显示状态：
闪红灯：处于充电状态
亮蓝灯：电量充满
- ⑥ OLED 屏幕
详情请参考“OLED 显示屏操作指南”（19 页）
- ⑦ 电源 / 静音键
开启 / 关闭电源 长按开关键直至开启 / 关闭
开启 / 关闭静音 短按开关键
- ⑧ SET 键
长按 SET 键进入菜单，短按为确认当前设置操作，再次长按取消当前设置操作。
- ⑨ +/- 按键（调整各参数数值大小）
- ⑩ Type-C 充电口（直流电 5V）

配件安装

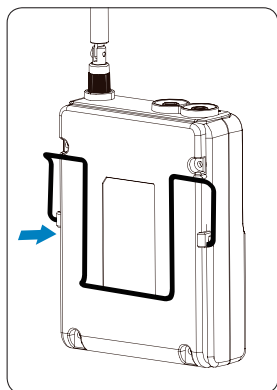

1. 将金属背夹对准发射器两侧的插入孔

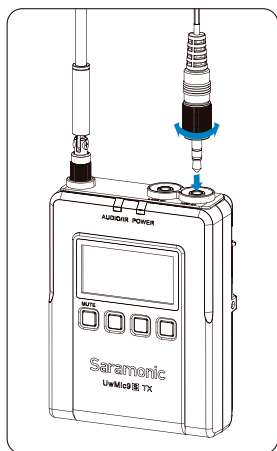

2. 接入麦克风
旋紧锁头固定麦克风位置

注意：在安装拆卸领夹麦之前，请先关闭发射器。

OLED 显示屏操作指南

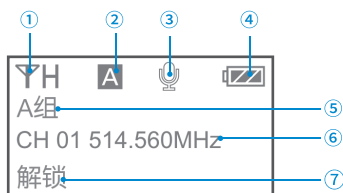

主菜单界面

如果超过 20 秒不操作，显示屏会自动跳转回主菜单界面。

- ① 射频信号图示
显示当前射频信号情况
- ② 通道图示（发射器所处通道）
- ③ 静音图示
🔊 正常收音状态 🚫 静音状态
- ④ 电池电量格
- ⑤ 通道名称
- ⑥ 当前频道和频段
- ⑦ 电源 / 静音键设置状态

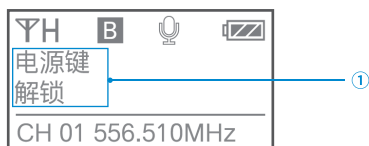

电源键设置

长按 SET 键设置锁定 / 解锁电源键。锁定电源键可开启防误触功能。

解锁状态：长按电源键开启 / 关闭（系统默认设置）

锁定状态：设定锁定选项后，防误触功能开启，长按电源键不会关闭设备。



通道设置

长按 SET 键进入菜单，“+”“-”选择频道后，短按 SET 键保存设置。



通道组设置:

A/B 通道组，每个通道组有 96 个频道（A 通道组为系统默认设定）



射频功率设置：低 / 中 / 高（高为系统默认设定）



静音键设置：开启 / 禁止静音功能（开启为系统默认设定）



麦克风增益设置：麦克风增益设置范围 00-08（05 为系统默认设定）



红外配对功能

配对过程中，屏幕显示“正在配对”

配对成功之后，屏幕显示“配对完成”

若在 20 秒内未配对成功，屏幕显示“配对超时”



背光灯设置:

LED 背光灯设置：常亮 / 延时 60/30/10 秒设定，（延时 30s 为系统默认设定）



确认恢复出厂设置后，TX 的相关参数将被恢复到默认出厂值。

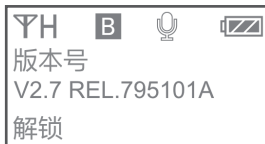

UwMic9S TX 当前版本号



语言版本设置：英语 / 中文 默认设置是英语

操作指南

1. 使用适配音频线连接接收器到相机 / 摄像机 / 混合器的麦克风口。

2. 长按电源键打开接收器。

3. 手动设置接收器频道

① 使用自动搜索频道功能



使用 +/- 键在接收器屏幕上选择“Auto scan (自动搜索频道)”



长按 SET 键进入“Auto scan ? (自动搜索频道?)”



屏幕会自动显示最少噪音和干扰的通道

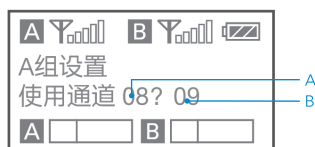

短按 SET 键确认

A. 表明当前最小噪声通道是 08, 并询问是否使用该通道。可以短按 SET 键确认使用该通道 (20 秒) 或长按 SET 键退出显示菜单且不保存设置。

B. 倒计时 20 秒。

注意:

① 20 秒后回到主屏幕, 设置不保存。

② 接通电源时可能会产生噪音, 可以调小相应接收器的音频输入电平。

② 手动设置接收器通道

• 使用 +/- 键在接收器屏幕上选择通道



• 长按 SET 键进入菜单选择



• 使用 +/- 键选择所需的通道, 并通过短按 SET 键确认。

4. 接收器和发射器的通道匹配

① 使用红外匹配 TX: 利用红外线传输技术, 将接收器上设定的频率, 传输到发射器

• 长按电源键打开发射器

• 在接收器上使用 +/- 键选择“Match with TX (启动配对)”



在发射器上使用 +/- 键选择“Match with RX (启动配对)”



• 同时长按接收器和发射器的 SET 键选择菜单, 短按“SET 键”确认。

• 将接收器的红外发射端口 (即 IR 指示灯处) 对着发射器上的红外探测端口 (即 IR 指示灯处), 请保持两者之间的距离小于 20 厘米。

• 如果接收器屏幕显示“Sync Finished (配对完成)”, 接收器和发射器匹配设置完成。

• 配对成功后, 接收器的 RF 指示灯会长亮起。显示屏会自动跳转回主菜单界面。

② 手动设置发射器通道

使用 +/- 键在发射器屏幕上选择通道设置功能



长按 SET 键进入菜单选择, 通过 +/- 键选择与接收器一样的通道, 并通过再次短按 SET 键来确认设置, 等待产品联机



联机成功后, 接收器的 RF 指示灯会长亮起

规格书

接收器 UwMic9S RX

频道数	96
频道组	A 和 B
调制方式	晶体控制锁相环合成器
操作距离	最远至 100 米
音频输出接口	3.5 mm A/B 通道输出孔 3.5mm 耳机监听孔
音频输入接口	3.5mm 麦克风 / 线性输入孔
天线	1/4 λ 导线天线
音频输出电平	-60 dBV
耳机输出电平	30mW (16 Ω)
载波频率	514 MHz - 596 MHz
灵敏度	-95 dBm
信噪比	≥ 75 dB
参考偏差	±5 kHz (-60 dBV, 1 kHz 输入)
频率响应	40 Hz 到 18 kHz (+/-3dB)
失真	≤ 0.2%
参考音频输入电平	-60 dBV (MIC 输入, 0 dB 衰减)
电池容量	2000mAh
供电方式	内置锂电池 / 直流电 5V
续航时间	8 小时
尺寸	87*64*25mm
重量	175g (6.17 oz)
工作温度	-10 °C ~ 50 °C
储存温度	-20 °C ~ +55 °C

发射器 UwMic9S TX

频道数	96
频道组	A 和 B
调制方式	晶体控制锁相环合成器
操作距离	最远至 100 米
音频输入接口	3.5mm 线性输入孔, 3.5mm 麦克风输入孔
天线	1/4 λ 导线天线
载波频率	514 MHz - 596 MHz
射频输出功率	≤ 10mW
信噪比	≥ 75 dB
参考偏差	±5 kHz (-60 dBV, 1 kHz 输入)
频率响应	40 Hz 到 18 kHz (+/-3dB)
失真	≤ 0.2%
参考音频输入电平	-60 dBV (MIC 输入, 0 dB 衰减)
电池容量	2000mAh
供电方式	内置锂电池 / 直流电 5V
续航时间	8 小时
尺寸	87*64*25mm
重量	157g (5.54 oz)
工作温度	-10 °C ~ 50 °C
储存温度	-20 °C ~ 55 °C

包装清单

UwMic9S Kit1 (TX+RX)

- 1 × 发射器 UwMic9S TX
- 1 × 接收器 UwMic9S RX
- 1 × DK3A 全指向型领夹麦克风
- 1 × 30cm SR-2004 二合一立体声 TRS 音频转接线
- 1 × 40cm 卡依转 3.5mm 带锁头 TRS 音频转接线
- 2 × 1.2m Type-C 充电线
- 1 × 80cm 3.5mm TRS 带锁头相机转接线
- 3 × 天线
- 2 × 背夹
- 1 × 冷靴座卡板

UwMic9S Kit2 (TX+TX+RX)

- 2 × 发射器 UwMic9S TX
- 1 × 接收器 UwMic9S RX
- 2 × DK3A 全指向型领夹麦克风
- 1 × 30cm SR-2004 二合一立体声 TRS 音频转接线
- 2 × 40cm 卡依转 3.5mm 带锁头 TRS 音频转接线
- 3 × 1.2m Type-C 充电线
- 1 × 80cm 3.5mm TRS 带锁头相机转接线
- 4 × 天线
- 3 × 背夹
- 1 × 冷靴座卡板



Scan the QR code and follow us!
扫描微信关注枫笛公众号

Shenzhen Jiayz Photo Industrial., Ltd
深圳市长丰影像器材有限公司

A16 Building, Intelligent Terminal Industrial Park of Silicon Valley
Power, Guanlan, Longhua District, Shenzhen, China
深圳市龙华区观澜街道大富工业区硅谷动力智能终端产业园 A16 栋

 400-613-1096

 www.saramonic.com

 info@saramonic.com